



Table of contents



1. Safety precautions.....	1
2. Standard accessories.....	3
3. Install machine.....	5
3.1 Installation and connection.....	5
3.2 Install cutting tool.....	6
4. Features of interface.....	7
5. Cutting plotter PCUT CT operating instructions.....	9
5.1 Name and functions of parts.....	9
5.2 Basic operation.....	11
5.3 Operating instructions.....	14
5.4 Technical features.....	21
6. Plotting servo machine PCUT S operating instructions.....	22
6.1 Name and functions of parts.....	22
6.2 Basic operation.....	24
6.3 Operating instructions.....	27
6.4 Technical features.....	36
7. Troubleshooting.....	37

1. Safety precautions

Definition of warning symbols:

	<p>WARNING</p>	<p>Any improper operation possibly results in hazard of life or damage of equipment.</p>
	<p>CAUTION</p>	<p>Any improper operation possibly results in hazard of life or other objects.</p>

Definition of sign symbols:

	<p>The symbol is prepared to arouse operator's highly attention. The symbols in triangles specify the cases to be attentive. The symbol in the left warns you of electric shock.</p>
	<p>The symbol specifies the activities to be forbidden. The symbol in the circle specifies the acts to be forbidden. The symbol in the left tells you no detachment.</p>



WARNING



Do not use the power source not meeting rating voltage, otherwise fire or electric shock may be resulted in.



If the machine gives out smoke or unpleasing smell, or noise sounds please do not use it .in such cases, continuing using it may result in fire or electric shock.



Do not put out the plug when the power is on to avoid damage to the machine.



Make sure the machine grounded otherwise electric shock or mechanic default may be resulted in.



Do not detach, repair or reconstruct the machine, otherwise fire, electric shock, hazard of life may be resulted in.



CAUTION



Do not leak any liquid or drop metal into the machine, such things may result in fire.

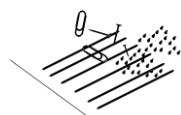

Do not touch the knife top with your finger to prevent injury or perspiration of knife head.



Do not damage or random replace the supplied power cable. Do not excessively bend, pull, bundle the power cable or place weight on it, otherwise the power source may be damaged even fire or electric shock is thus incurred.

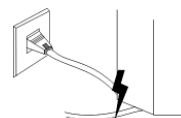

If you are not going to use the machine for a long time, please unplug the power cable from the receptacle, otherwise fire possibly happens.

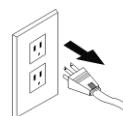

When operating the machine, do not place either of your hands on capstan to avoid injury.



Place the machine on a stable surface, otherwise the machine may fall therefore get damaged.



To unplug the power cable from receptacle, please hold the plug instead of the cable, strongly pulling of the cable possibly results in electric shock or fire.

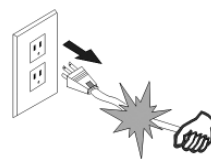



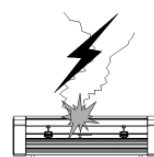

Any operation is forbidden in case of storm or lighting to prevent damage of the machine.

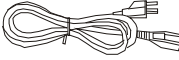

2. Standard accessories

Please first check following accessories after unpacking, please contact the seller or our company if you find anything missing.

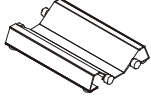
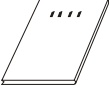
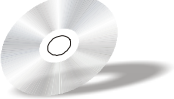
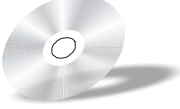
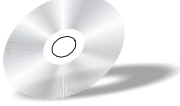
Serial No	Item	Quantity	Icon
1	Power cable	1	
2	Signal cable	1	
3	Rotary tool apron	1	
4	High-speed tungsten steel knife	3	
5	Paper-tube bracket (desktop's machine special fitting)	1	
6	Operating manual	1	
7	Wentai software (optional)	1	
8	Cutting & plotting master (optional)	1	
9	PLTDraw Software (optional)	1	

10 Vertical Foot Stool and Installation Sketch Map

(Available to the type with minimum width of 1000mm only)

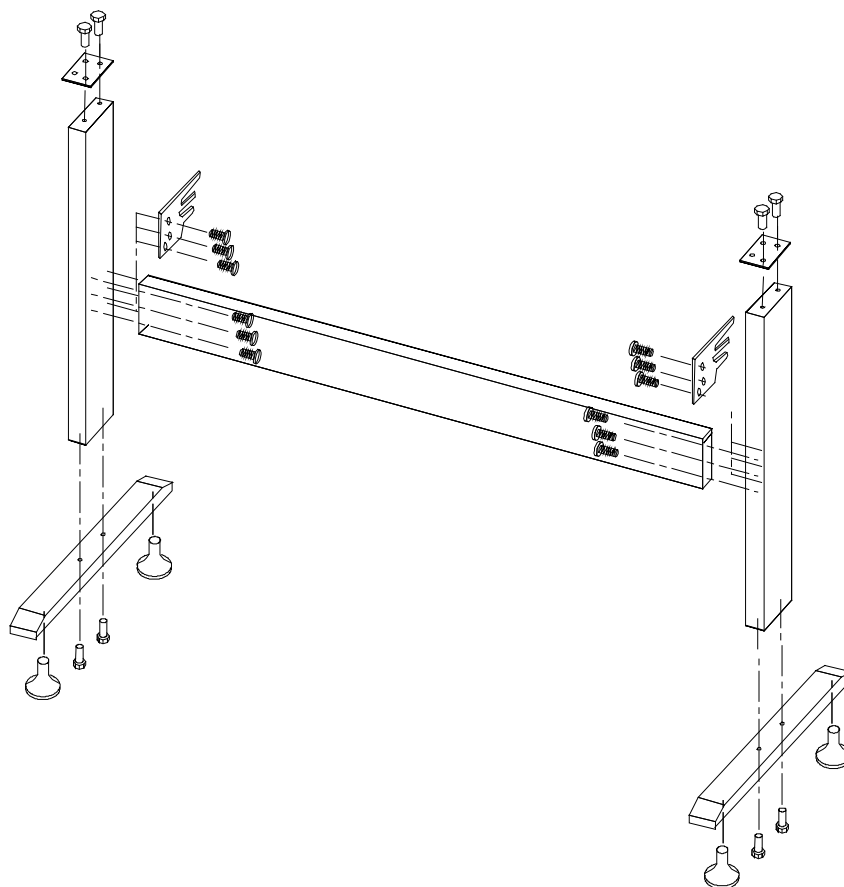

Take parts of the foot stool out of the pack, open the parts bag, install the foot stool as the map shows. After installation place the host on the support with screw hole targeted, then fasten it with screw.

3. Basic operation

3.1 Installation and connections



WARNING



Make sure this machine is grounded, otherwise electric shock or mechanic default is possibly resulted in.



Do not use the power source not meeting rating voltage Using the wrong power source may result in fire or electric shock.



Do not put out the plug when the power is on to avoid damage to the machine.



Place the machine on a stable surface, otherwise the machine may fall therefore get damaged.



3.1.1 Place the cutter in a plane and roomy place.

3.1.2 Connect signal cable to COM1 or COM2 port of the computer host.

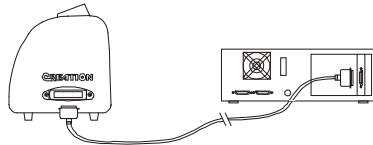

3.1.3 Place the bracket behind the host, ensure it is parallel to the host.

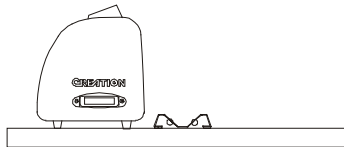

3.1.4 Check voltage of the power source and whether it is grounded, do not connect to power until all are in a good condition.

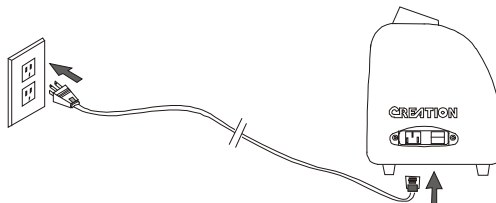

3.2 Installation of tool



CAUTION



Do not touch the knife top with your finger to prevent injury or passivation of knife head.



3.2.1 Fit cutter into rotary tool, the knife and tool are as shown in following drawings:

(outside drawing)



(exploded view)

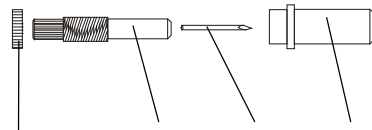

Knife adjusting screw

Knife handle

Knife

Knife sheath

3.2.2 Adjust the protruding length of the knife top as required for specific cutting media.

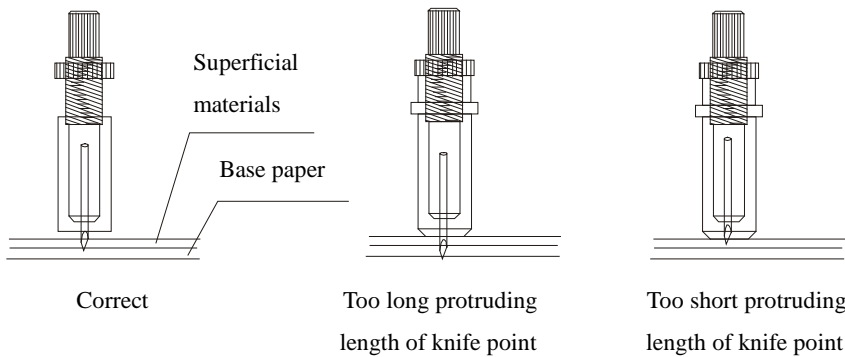

- 3.2.3
- (1) Loosen the screw of tool carrier.
 - (2) Assembly the tool with knife into the tool carrier.
 - (3) When the tool is in appropriate position screw it and fix the screw.

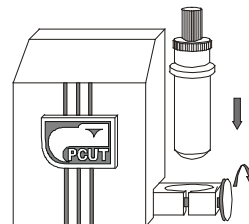

4. Features of interface

Cutting plotter PCUT provides an input interface, serial RS-232 interface, which is connectable with a wide range of computers.

Properly connect signal cable of the interface will enable the cutter accurately respond to plotting and engraving command from computer. Improper connection of the cable may result in trouble even lock up of the machine.

RS-232 Serial Interface:

RS-232 Serial Interface meets features of ELA (Electric Industries Association).

General features:

Standard: CCITT V14, EIA RS-232C, JIS×5101

Baud rate: 300、600、1200、4800、9600baud

Stop bit: odd/even/none

Word length: 8bit

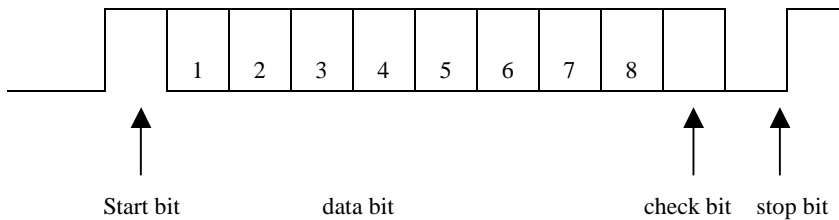

* RS232C foot definition:

Pin No	Sign SYS	RS232C	CCITT 24	Signal Dissection
1	FG	AA	101	
2	SD	BA (TDATA)	103	← P
3	RD	BB (RDATA)	104	→ P
4	RS	CA (RTS)	105	← P
5	CS	(CTS)	106	→ P
6	DR	(DSR)	107	
7	SG	AB (SGND)	102	
8-19				
20	ER	CT ()	108	← P
21-25				

* Electric parameters:

		RC, SD		RS, CS, DS, ER	
		Negative		Positive logic	
Input voltage level	+5v to +12v	Logical "0"	"ON"		
	-5v to -12v	Logical "1"	"OFF"		
Input voltage level	+5v to +12v	Logical "0"	"ON"		
	-5v to -12v	Logical "1"	"OFF"		

* Connector:

Cutting plotter port: DB-25S

Signal computer port: DB-25P

* Map of serial interface cable connecting between IBM-PC computer and cutting plotter.

Cutting plotter port

Signal computer port

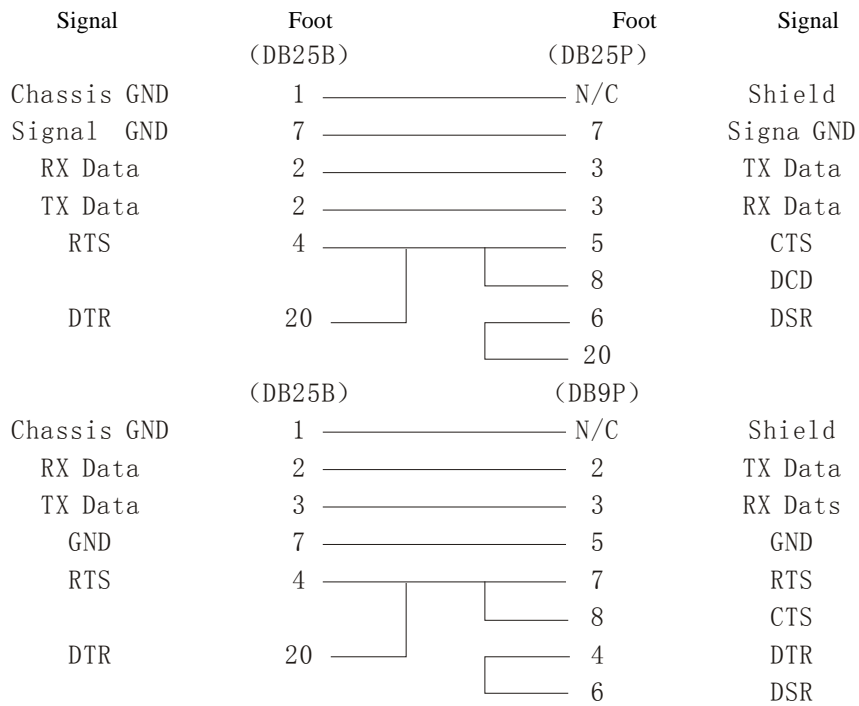

5. Cutting plotter PCUT CT operating instructions

5.1 Names and functions of parts

5.1.1 Frontal view

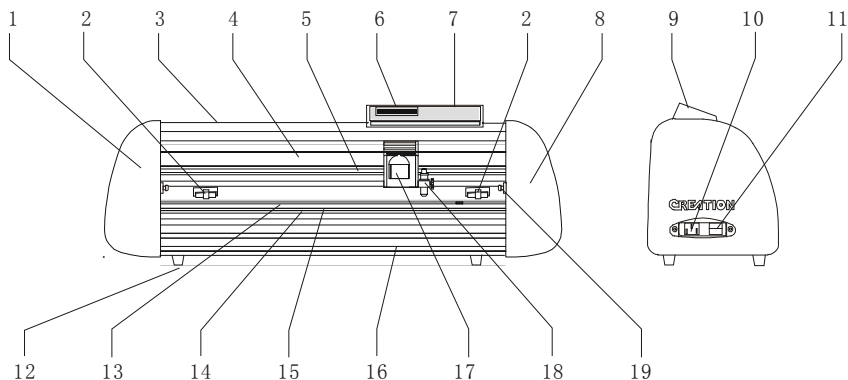

- | | |
|-----------------------------------|-------------------------|
| 1.Left cabinet | 11.Power on/off |
| 2.Paperweight wheel | 12.Foot cushion |
| 3.Upper cover | 13.Y Transmission Shaft |
| 4.Beam | 14.Scale |
| 5.Tooth profile transmission belt | 15.Strip cushion |
| 6.LCD (Liquid Crystal Display) | 16.Trimming groove |
| 7.Control keyboard | 17.Slider |
| 8.Right cabinet | 18.Knife clip |
| 9.Keyboard base | 19.Reset |
| 10.Receptacle of power source | |

5.1.2 Back view

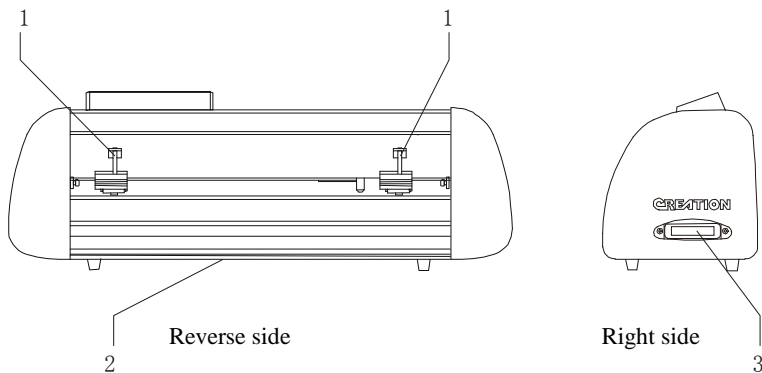

- | | |
|-------------------------------|--------------------|
| 1.Handle of paperweight wheel | 3.RS232 Receptacle |
| 2.Baseboard (containing main | |

5.1.3 Control panel

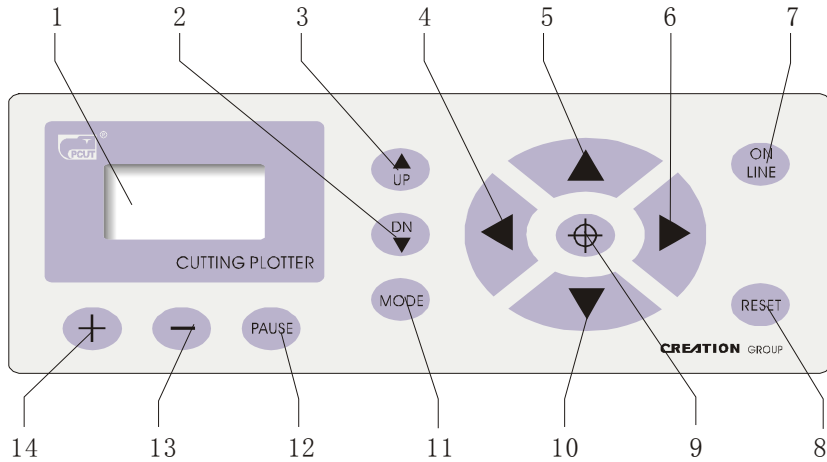

- | | |
|---------------------------|--------------------------------------|
| 1.LCD Display | 8.Host reset |
| 2.Knife-dropping button | 9.Origin setting button |
| 3.Knife-raising button | 10.Paper-feeding button |
| 4.Leftward button | 11.Systemic parameter setting button |
| 5.Paper-withdrawal button | 12.Pause |
| 6.Rightward button | 13.Value + |
| 7.Online/offline button | 14.Value - |

5.2 Basic Operation



CAUTION



When switching on the power, make sure your hands and other articles are out of reach of such running parts as main shaft and slider to prevent injury.



5.2.1 Turn on the machine

5.2.1.1 Check whether the power is in OFF position.

5.2.1.2 Plug the cable into the receptacle of the host power source, press the power on/off on the left.

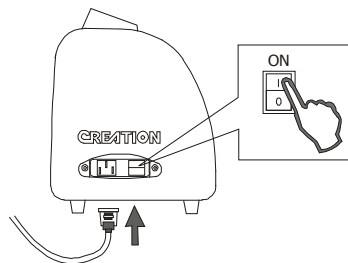

5.2.1.3 LCD in the control panel is ON and displays the initializing process of the host and shows following information:

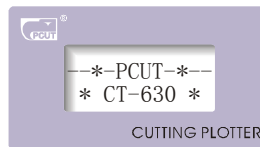

5.2.1.4 When the initializing is over, the machine is in online state and connectable with the computer to be operable.

5.2.2 Installation of cutting media

This machine is suitable not only for single-sheet media, but also a roll of media.

- 5.2.2.1 Press down the handle of paperweight wheel behind the machine to raise the paperweight wheel.

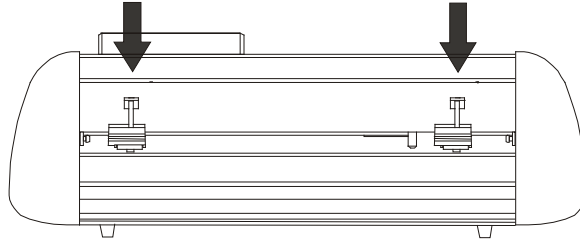

- 5.2.2.2 Insert the media into the space between paperweight wheel and main shaft, and pull out the media to appropriate length from the front of the host.

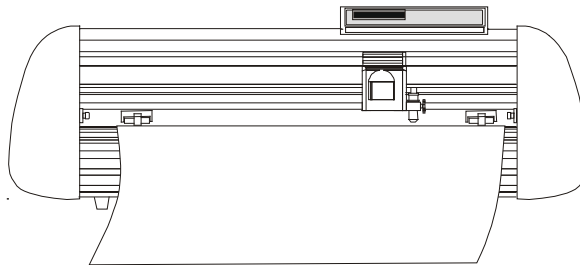

Using roll of media

Pulling it out to required length

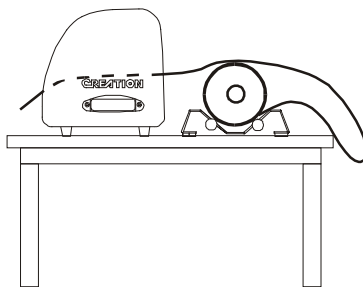

Using single sheet of media

Cutting required length from paper roll

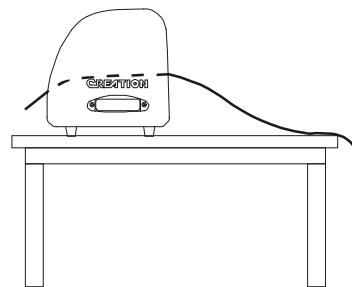

- 5.2.2.3 Adjust horizontal position of paperweight wheel according to width of paper. a distance of minimum 1-10CM is set between paperweight wheel and paper edge to ensure good running of paper.

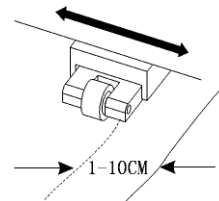

- 5.2.2.4 Raise two handles of paperweight wheel, to make paperweight wheel down to press paper.

5.2.3 Trial run (adjusting knife press and tool)



CAUTION

Do not touch the knife top with your finger to prevent injury.



Quality of knife immediately relates to cutting precision and life of machine. To better your work, please use the standard knives we confirm, but not those with poor quality.

5.2.3.1 Press ON LINE button to make the machine in off-line state.

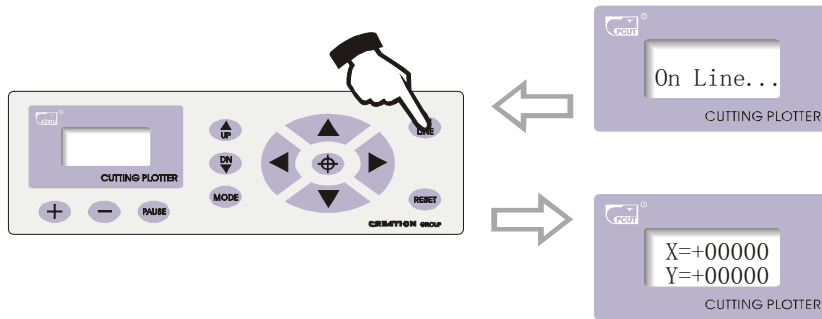

5.2.3.2 While in off-line state, press PAUSE twice, the machine will automatically cut a small square from the media.

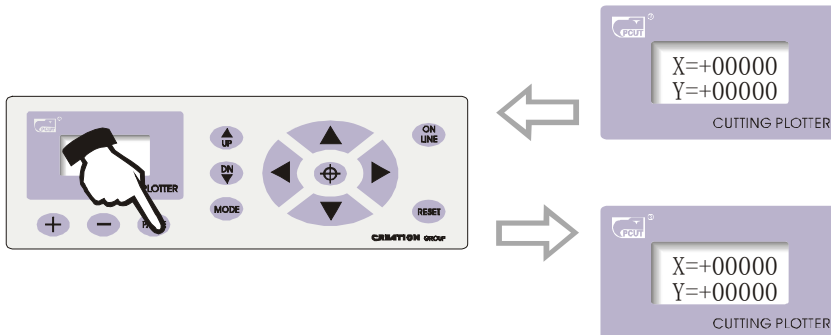

5.2.3.3 Take off the square, if you fail, the square need to be further cut, because the press is low or the protruding length of knife top is too short; If the base paper is pierced through, it signifies that the protruding length of knife top is too long and the press is too big. Adjust the protruding length of knife top and knife press according to result of trial run and the description of tool installation.

5.2.3.4 Press + or - to adjust knife press, for common materials the knife press value ranges from 100 to 120.

5.3 Operating instructions

5.3.1 On-line / off-line

When the cutter starts reset, it becomes in online state. Press ON LINE to switch between online and off-line state. When computer transmits information to the cutting plotter, the cutting plotter must be in online state. However, when setting parameters for the machine or operating it by hand, you should set it in off-line state. The LCD will display the following information.

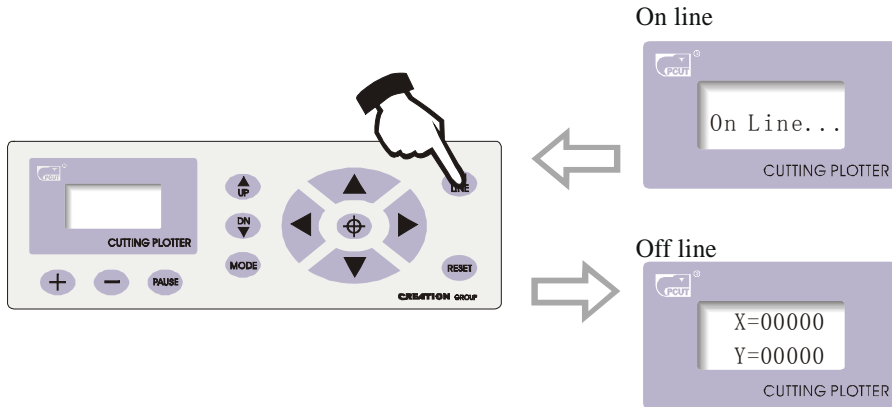

5.3.2 Moving knife top

While in off-line state, press “◀ ▶” buttons to move the slider leftward or rightward.

When pressing “▲ ▼” buttons the main shaft will rotate forward or backward, and the step value of “X, Y” in the LCD will change accordingly.

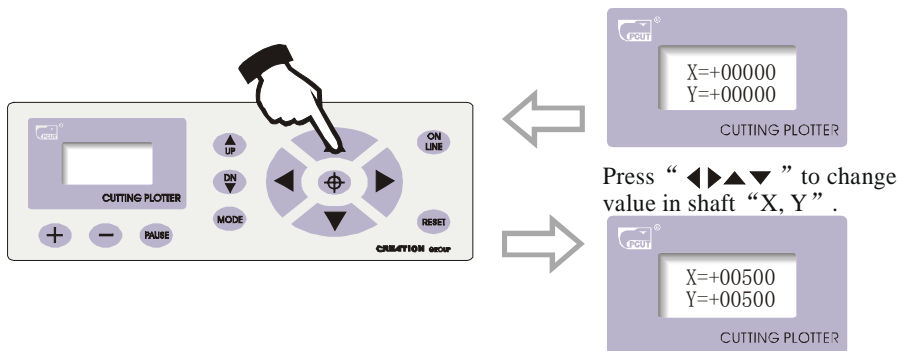

5.3.3 Setting origin of plotting

When move the knife top to the starting position, press the origin setting button “⊕”, the values of “X, Y” will be set as 0, the setting of new origin is completed. The machine will start plotting from the new origin. To save the present origin please refer to chapter “ saving and using relative origin”.

Setting arbitrary origin

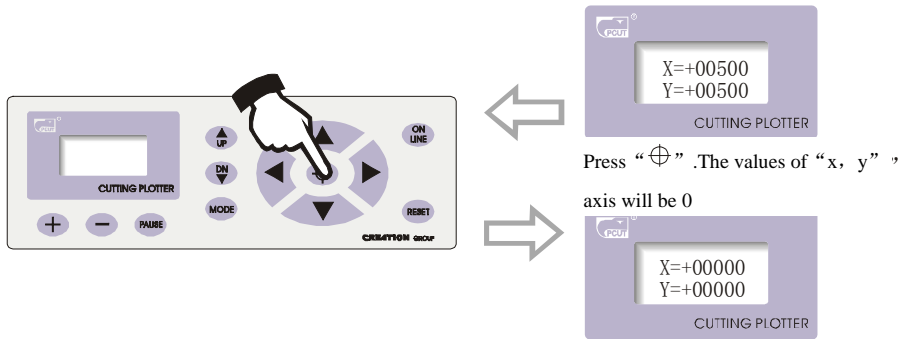

Relational map between absolute origin and arbitrary relative origin.

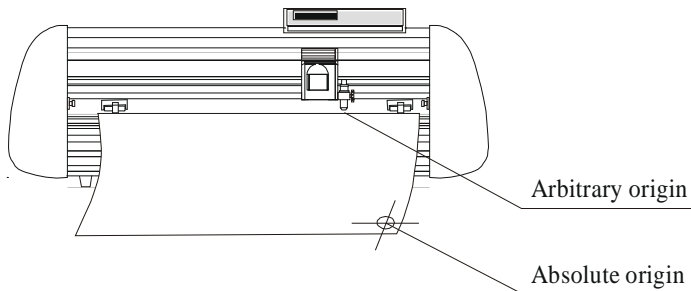

5.3.4 Raising knife, dropping knife

While in off-line state, press DN button, the knife will fall, then press UP button to raise the knife.

Press “ \blacktriangledown ” to drop the knife

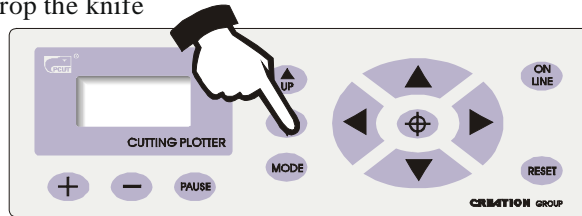

Press “ \blacktriangleup ” to raise the knife

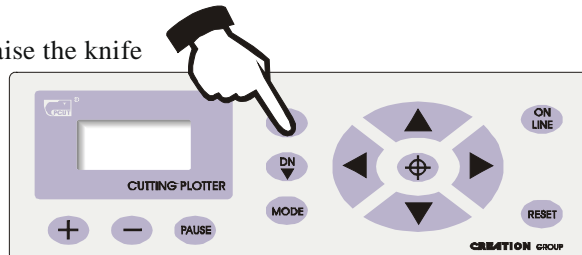

5.3.5 RESET

Press RESET button, the machine will reinitialize, the present position of knife top will be set as new starting origin, all data in buffer memory will be cleared.

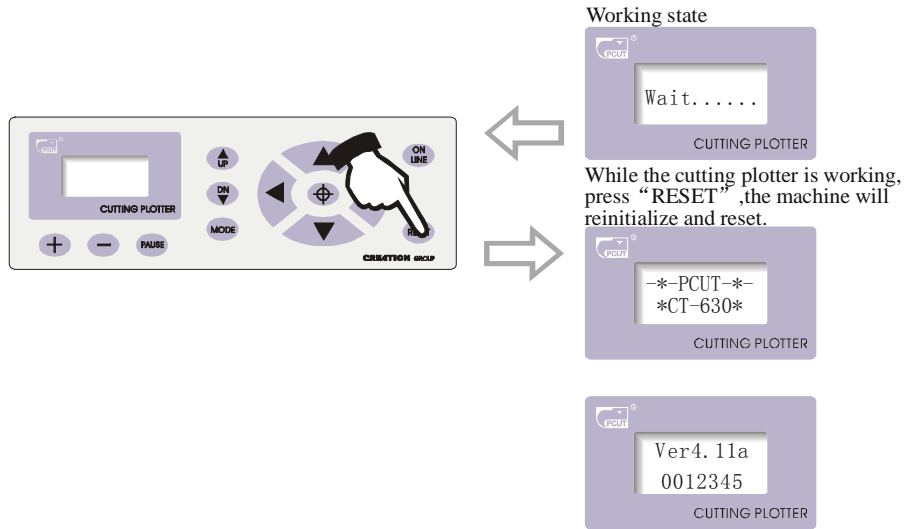

5.3.6 System setting and storage

While in off-line state, press "MODE" button to set system parameters, the LCD will display the options of system parameters. Press "MODE" button to show the options in turn, press "+" or "-" to change the parameter value of selected option. When the setting is completed, press "PAUSE" to escape setting mode, press "ON LINE" and save the setting value.

For example, in speed setting state:

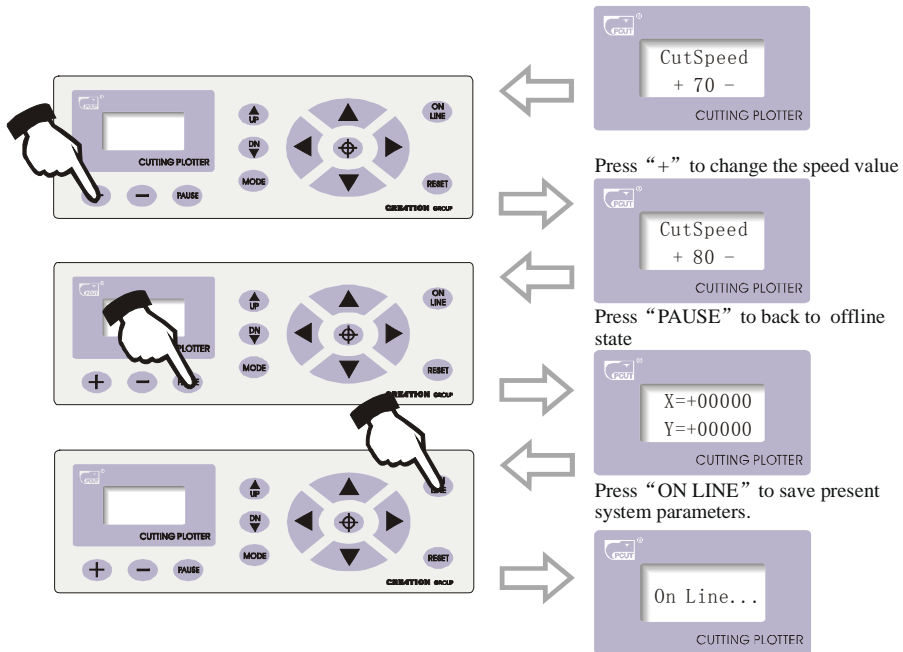

Flow chart of system setting

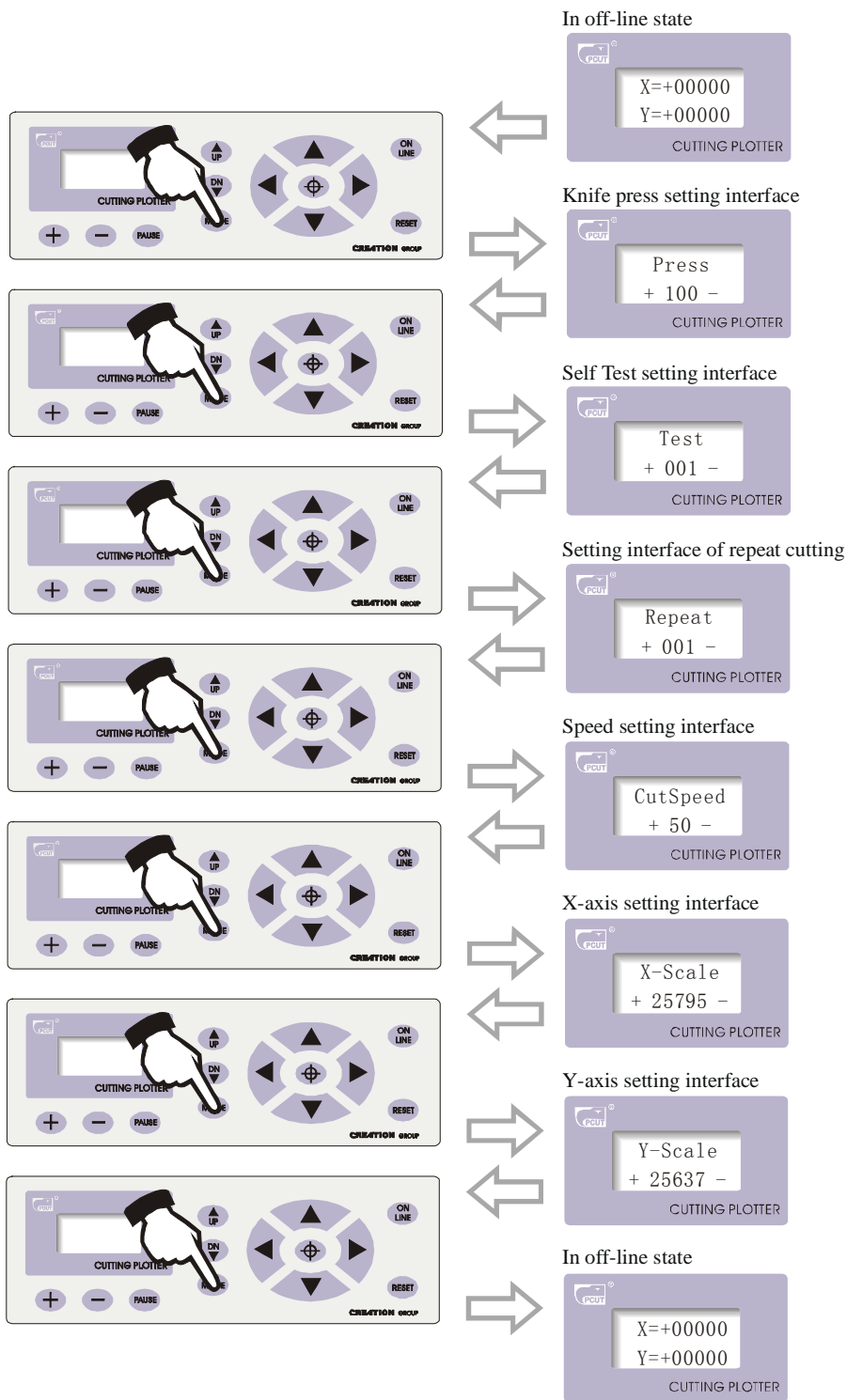

Press “+” and “-” to change the parameters of system. To save present set system parameters, press “PAUSE” button to escape setting mode in off-line state, then press “ON LINE” button once. When switching on machine next time, it will automatically call in the parameters which were set last time as default for starting up.

5.3.7 Diagrammatic demonstration of setting parameters for different states

5.3.7.1 Setting knife press

In off-line state, The value of “Press” signifies knife press, press “+” to increase it, press “-” to lower it. the setting values range is 0~255, namely the knife press can range within 0~800g. When the machine runs, if the knife press is found unsuitable, press “PAUSE” button, then press “+” or “-” to make press up or down.

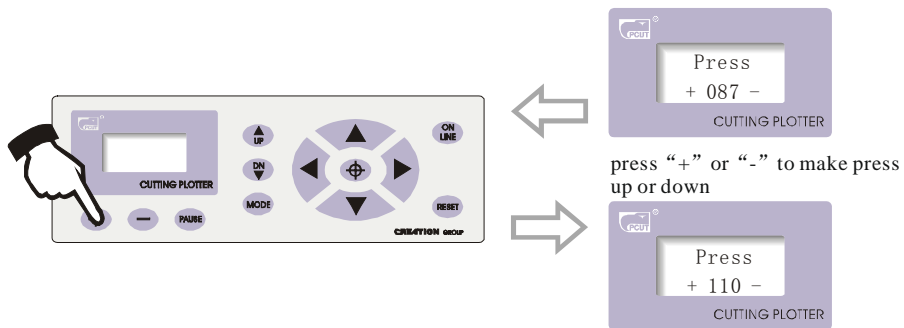

5.3.7.2 Setting Self Test interface

In “Test” state, press “+” to increase testing times while press “-” to decrease testing times, the range of testing times is 0 ~ 255. Press ON LINE button to start plot Demo Test graph. Testing with knife installed can be done one time only. To repeat the testing, please replace the knife with plot pen, with which you can test repeating precision of the machine. If the Self Test meets requirement, it indicates that parts of the machine are in good condition.

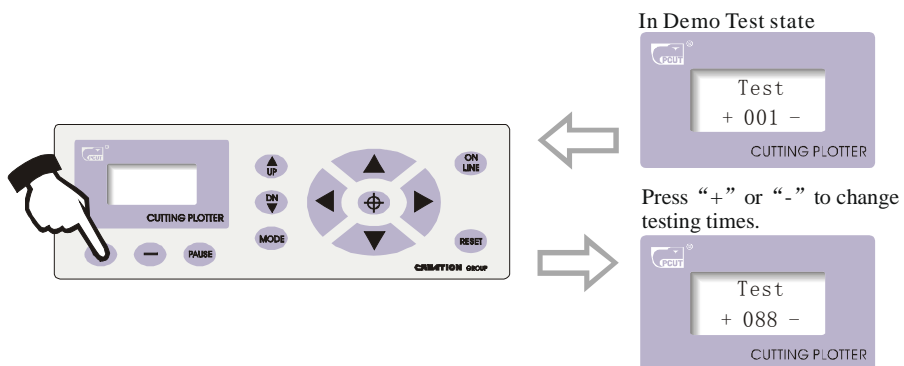

5.3.7.3 Repeat cutting

When the data computer transmits can be totally stored into memory of the machine, this function can be used to plot more than one copy. In “Repeat” state, press “+/-” to adjust total copies to be duplicated, press “ON LINE” to start plotting. The maximum 255 copies can be duplicated. At one time (this function is limited to memory, the capacity of the document shall be low 1024kb).

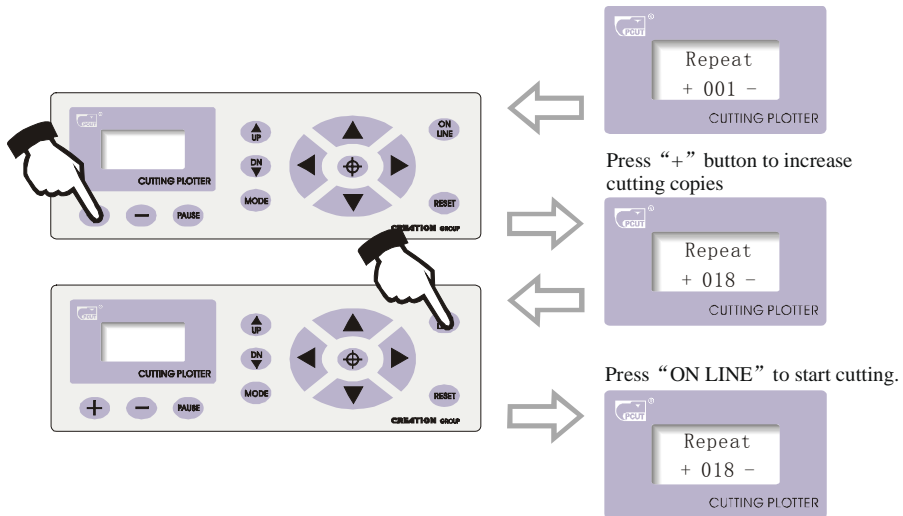

5.3.7.4 Cutting speed

In speed setting mode, press“+”or“-”to adjust cutting speed, high speed is suitable for cutting big characters or image, while low speed is suitable for exquisite small character or image. 10-shift speed is available for your choice:

10 → 20 → 30 → 40 → 50 → 60 → 70 → 80

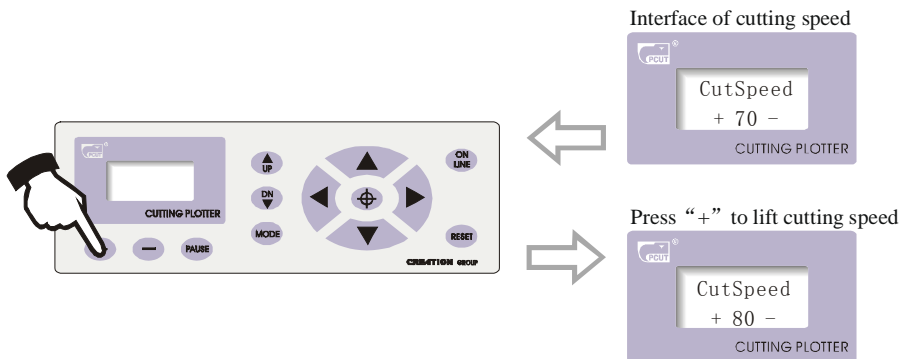

- When cutting at high speed, curve may look zigzag, but it is not a trouble, lowering the speed will eliminate the indentation.

5.3.7.5 Interface for setting X-axis, Y-axis

To minimize the error in mechanic size, set ratio of “X, Y” to be adjustable, and make composing size conformed to plotting size.

When real size of shaft “X” or “Y” exceeds composing size.

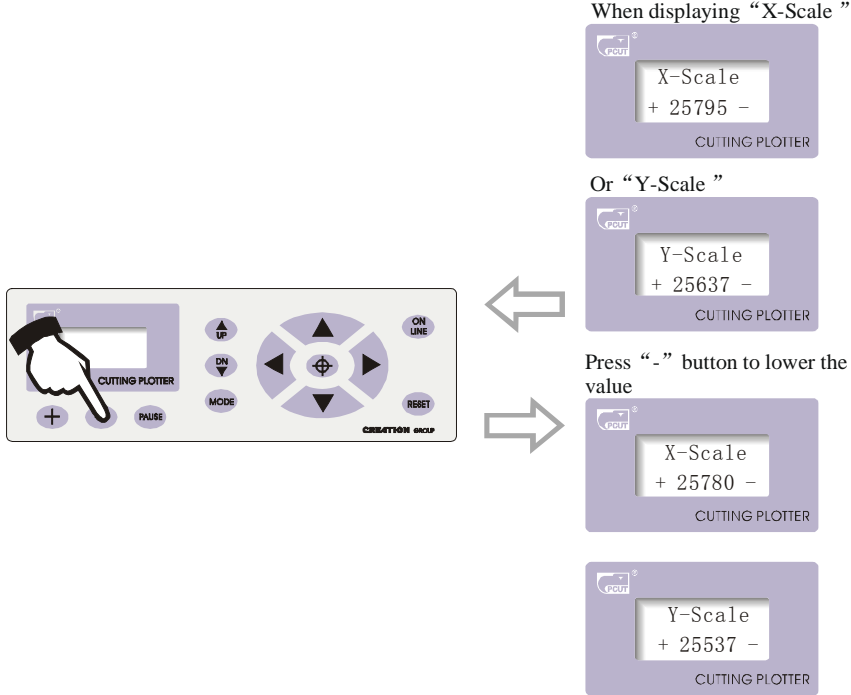

Contrarily, in “X-axis” or “Y-axis” state press “+” to increase the value.

Notes: when using this function, meticulous adjustment to specific speed and media is desirable.

5.3.7.6 Readjustment of initial value

When client disorders speed and other parameters therefore having no way to work and lack experience to back to ideal cutting state, he can adjust it to initial value.

Operating procedures: press “MODE” button to “CUT SPEED” state.

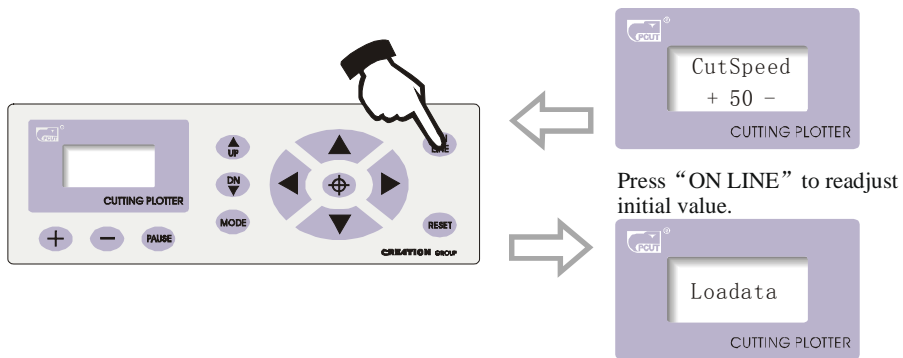

5.4 Technical features

Type	CT 630	CT 900	CT 1080	CT 1200	CT 1500
Bracket and paper feeding mode	Table-type M paper foot stool	Vertical feed paper foot stool			
Main board	16-bit CPU, 1Mb High-speed CACHE memory				
Control panel	Over-head, 2 x 8 Liquid Crystal Display, 13-button touch thin-film keyboard				
Drive	Main shaft double high torsional motor, micro-step and subdivision driving				
Positioning mode	Bounded system, arbitrary origin setting, 10 Couples origin saving and transfer				
Maximum paper feed width	730mm	1000mm	1100mm	1300mm	1625mm
Maximum cutting width	640mm	910mm	1010mm	1210mm	1535mm
Maximum cutting speed	600mm/s				
Maximum cutting length	1500mm (rate <=20 hours) / 15000mm (20 <rate <=60 hours) / 5000mm (rate)>=70hours				
Maximum cutting thickness	1mm				
Knife press	0-800g (digital adjustment)				
Mechanism precision	0.025mm				
Repeatable precision	<+0.1mm				
Type of tool	Sweden SANDWIK hard alloy steel knife				
Type of plot pen	Atom plot pen and poster pen with a diameter of 11.4mm, watery or oily				
Plotting instruction	DM-PL/HT-GL(TM) automatic identification				
Interface	Standard RS232 (serial) / Centronics (parallel)				
Power source	Ac220 ± 10%. 50Hz				
Power consumption	< 100VA		< 120VA		
Operating environment	Temperature: +5 - +35, relative temperature 30% -70%				
External size	1030X275 X380mm	1200X260 X1070mm	1300X260 X1070mm	1500X260 X1070mm	1825X260 X1070mm
Transporting weight	22kg	40kg	42kg	45kg	55kg

7. Troubleshooting

7.1 Question: will the characters below 1CM be deformed?

Answer: when graving small characters, please set sharp-angle compensation in the software, for example, in Wentai plotting software:

- (1). Click “plotting output” once, a plotting output picture will pop up.
- (2). Click “set” once, a picture of setting plotter will pop up.
- (3). Click “compensation setting” , a dialog box will pop up.
- (4). Select “sharp-angle compensation” , adjust the value to required level.

The compensation ranges within 0.1-0.7, more often we set it to be 0.25. in addition, the plotting speed of the cutter shall be set below 20.

7.2 Question: Why there is an additional stroke after finishing cutting

- Answer:
1. check if the tip of cutter is flexible when it is up and down .
 2. change the Master software if there are some deviant letters .
 3. check if there are some problems on the files you are ready to output .

7.3 Question: why does zigzag happen to the cutter?

Answer: as cutter PUCT motor features high power and speed, so the cutting speed shall be adjusted according to size of character. Generally, to cut small glossy characters with high requirement for precision, the speed shall not exceed 40. In most cases, the speed at the shift 50-60 is favorable. To cut big characters of large quantity within shortest time, the speed can be 70, 180, but since step distance of motor is so long that evident zigzag occur. Therefore, you should set the speed to specific size of characters, and the relationship between speed and size of characters please refer to following table:

Size of font (mm)	SPEED
< 10	10-20
10-30	30
30-50	40-50
50-500	60
> 500	70-80

7.4 Question: why do the paper deviate when it runs by a large margin?

Answer: the paper feed bracket containing paper roll shall be completely parallel to paperweight wheel, for big roll of materials, loosen it prior graving to prevent excessive obstruction when plotting or graving. For the machines with four paperweight wheels, when plotting big image or characters back and forth, use the two paperweight wheels at sides instead of press the four down simultaneously. Unequal abrasion of the two wheels also may result in deviation of the paper; in worse case replacing wheels is needed.

- 7.5 Question: why does lock up happen in plotting output?
Answer: (1). Exterior 220 V input voltage is too low (150V), the plotter will restart thus lock up happen.
(2). When disturbance of exterior 220 V input voltage is too high, lock up may happen, to resolve it you can use purified regulated power source.
- 7.6 Question: Why does the machine feel tingle?
Answer: the machine might be improperly grounded, make sure central line of the power source grounded.
- 7.7 Question: why does the job feel not smooth with sharp-angle raised when plotting?
Answer: (1). The protruding length of knife top is too long, please adjust it as required.
(2). The knife is abraded, replace it.
- 7.8 Question: why does the plotter first scratch a line before plotting?
Answer: because the machine illegally escape last time, there is still knife-dropping instruction existing in the memory of plotter. To resolve it power off the machine and turn it on again.
- 7.9 Question: No LCD display or a black row of blocks are displayed?
Answer: (1). In case of no display, check whether the power work well.
(2). If black blocks are displayed, check whether voltage is at required level. If troubles remain after the above operation, please contact maintenance center.
- 7.10 Question: why can not some characters close in strokes when it is plotting?
Answer: because the knife of the plotter is eccentric knife with a eccentric value, to resolve it, set "closing compensation" in the software. For example: in Wentai software:
(1). Click "plotting output" once, a plotting output picture will pop up.
(2). Click "set" once, a picture of setting plotter will pop up.
(3). Click "compensation setting" a dialog box will pop up.
(4). Select closing compensation, adjust the value to required level, generally the value is set to be 0.5.
- 7.11 Question: Why the machines have missed some pave of letter when cutting?
Answer: (1). Check the machine if it presses enough.
(2). Reinstall the software.
(3). Chook the head of the knife.
(4). If the problem is still in existence, please contact with repair center.
- 7.12 Question: why is the machine in low-speed state after start-up?
Answer: Because paper sensor fails to detect the fore end of paper. When feeding paper make fore end of paper cover hole of paper sensor, then perform another automatic paper testing.

7.13 Question: why do some nicks deep, while some shallow when cutting?

Answer: as PCUT employs upscale soft PVC materials as knife strip cushion to protect knife. But long period using it may produce a trace therefore roughing the stripe cushion, so some nicks become deep, while some become shallow. To resolve it replace a stripe cushion. If is not so worse, adjust knife as described in section 3.2.B, increase knife press (some 120 -150)。

7.14 Question: why can not the plotter run when it is outputting?

Answer: (1). Check whether the plotter is properly connected with computer. PCUT is connected with COM1 or COM2 of computer; check whether the set ports are conformed to those connected。

(2). Check whether the plotter is in online state, namely whether the LCD displays “ON LINE”。

(3). Check whether the encryption card of software is properly. If not please turn off the power and reinstall it. Check driving program of the plotter is for PCUT series。

7.15 Question: why can not the instant-glue be taken off?

Answer:(1). Perform trial run prior output, adjust press to appropriate level.

(2). Check whether the knife is used too long, or whether the knife top is broken. For new ones the nick is thin in the instant-glue, while for old ones the nick is thick and impressive. To resolve it replace it with a new knife。

7.16 Question: what is attentive when cutting big characters?

Answer: (1). When cutting big characters, the system can automatically How to setup page, you can cut a big character in several pages, but it is notable that the setting of output width shall be conformed to the width of instant-glue in addition, when cutting big characters and output it, you should widen pages or set seaming distance。

(2). When you use the special wide machine to cut the big characters, especially the long big characters Before cutting input, you shall instead the paper first look careful the paper if the paper deviates then deviate the big characters into some pouts to input, it can make sure it won't deviate and waste paper。

7.17 Question: how do we maintain the plotter?

Answer: PCUT series plotter all employ upscale oil bearing from Japan, no oil is needed even it works for a long time. After operation everyday, clean the dust with soft brush. The glue remaining in engine base can be cleaned with alcohol. If frequently operated in dusty environment above two years, please have maintenance technicians clean the dust in machine. If plotting precision degrades, the maintenance of running parts are desirable (firming and replacing the abraded parts)。

7.18 Question: Why does the plotter is out of our control sometimes?

Answer: maybe while transporting or using it, the signal line is improperly connected, open the machine properly plug all lines. If the problem still fails to be solved after the above operation, please contact local agent or maintenance center.

7.19 Question: Why does the plotter come to halt?

Answer: because it encounters vibrate for a long period, or has been used for a long period, or is affected by temperature, so dielectric displacement happen to the servo driving board, therefore resulting in halt, please contact local agent or customer maintenance center.